

**4/S5**  
v 3.4 (en)

## CONSTANT VOLUME DAMPERS

RKP-C-N, RKP-P-N, KVR-R

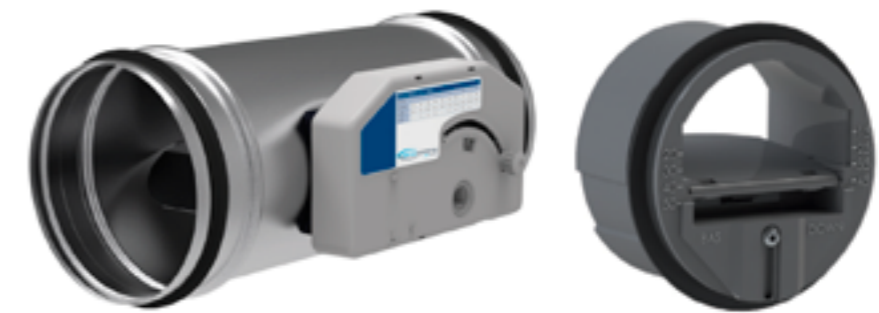

**RKP-C-N**

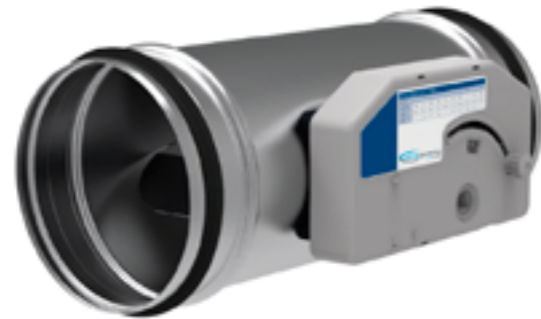

- For maintaining constant air volume in ventilation systems, without additional power supply
- Made of galvanized steel sheet, damper blade made of anodized aluminium sheet
- Recommended airflow velocity from 3 to 8 m/s, at pressure difference  $\Delta p > 50$  Pa
- Adjusting required constant amount is done by turning of working screw on the right side of the cover

Working temperature : -20...80°C  
 Relative humidity: 5...80% rh  
 Constant flow:  $\pm 10\%$  set value  
 Casing airtightness: Class C

Dimensions RKP-C-N

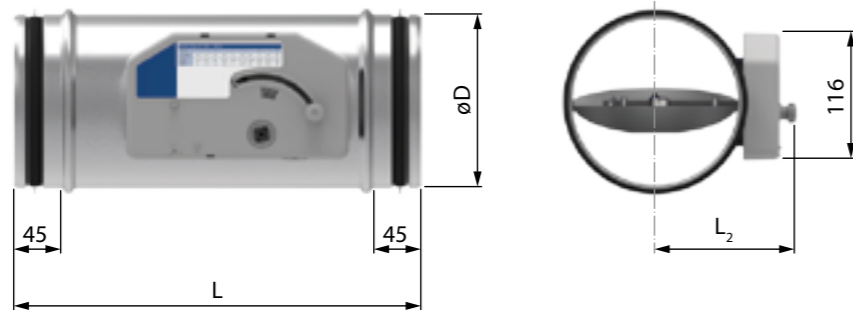

Dimensions RKP-C-Z-N

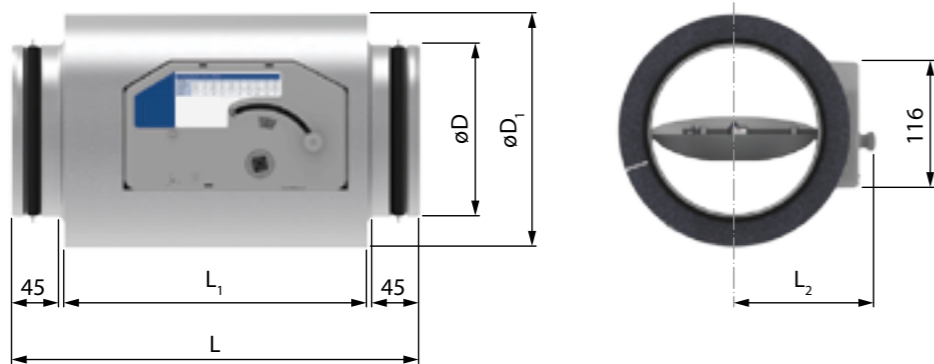

Dimensions

Dn [mm]	V <sub>min</sub> [m <sup>3</sup> /h]	V <sub>max</sub> [m <sup>3</sup> /h]	øD [mm]	øD <sub>1</sub> [mm]	L [mm]	L <sub>1</sub> [mm]	L <sub>2</sub> [mm]	m [kg]	m(z) [kg]
100	79	264	98	155	350	251	93	1,2	2,0
125	135	387	123	180	360	261	106	1,4	2,4
160	227	662	158	215	380	281	123	1,8	3,2
200	335	954	198	255	400	301	143	2,3	4,2
250	517	1644	248	305	425	326	165	3,6	6,1
315	769	2423	313	370	485	386	201	5,0	8,7
400	1372	3947	398	455	530	431	243	6,9	12,2

Fast selection diagram

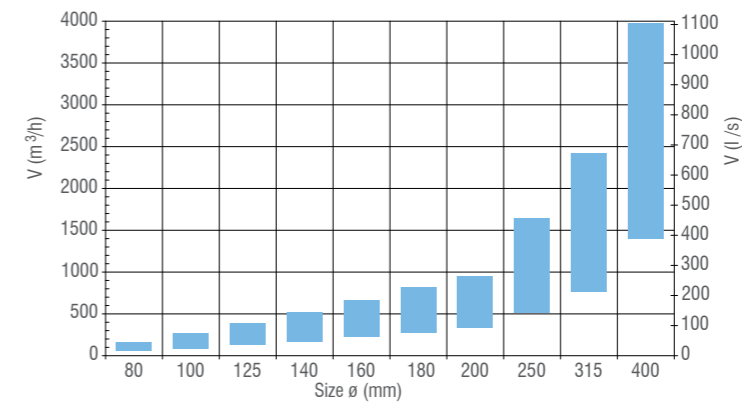

Installation

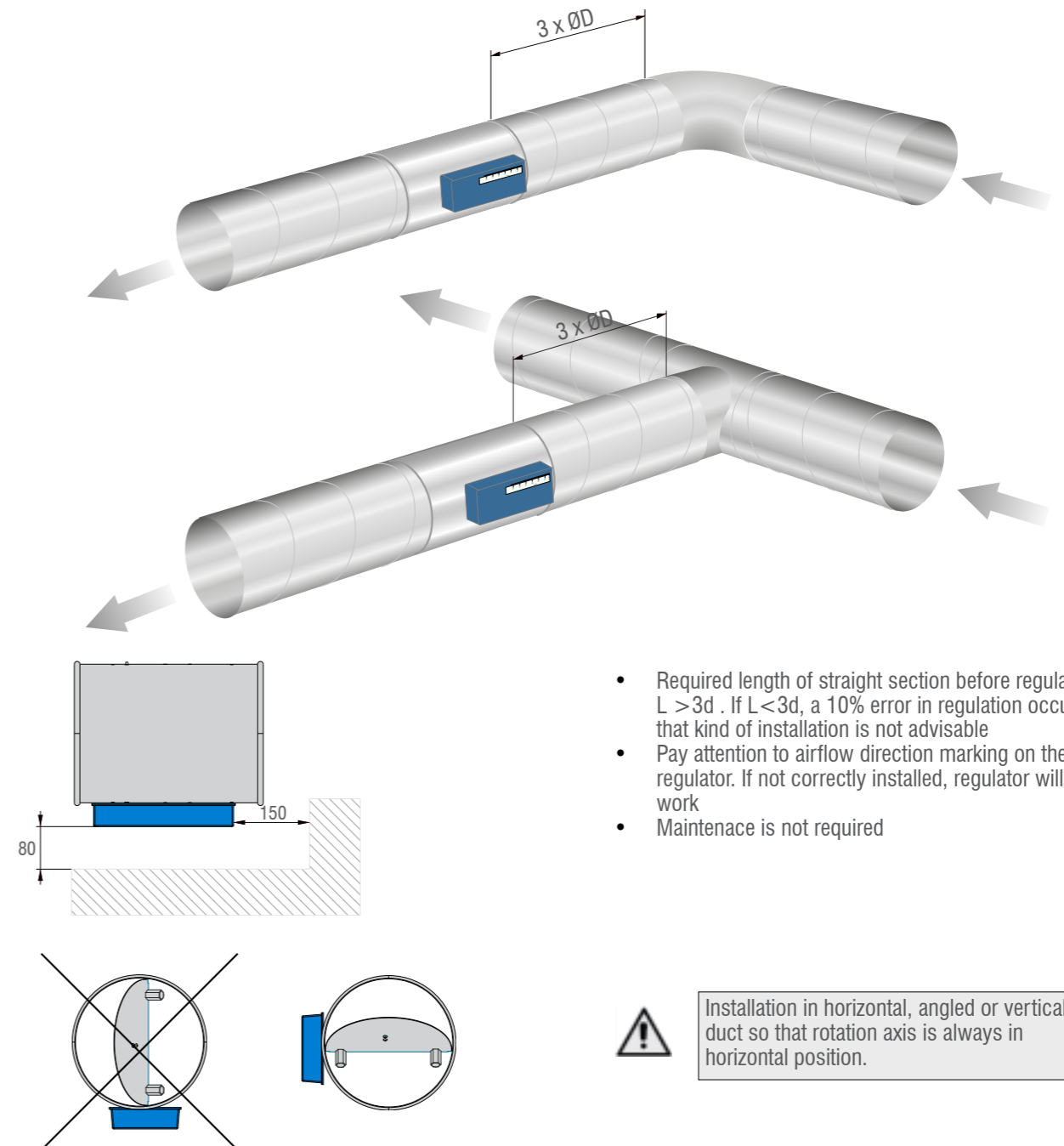

- Required length of straight section before regulator is  $L > 3d$ . If  $L < 3d$ , a 10% error in regulation occurs so that kind of installation is not advisable
- Pay attention to airflow direction marking on the regulator. If not correctly installed, regulator will not work
- Maintenance is not required

**!** Installation in horizontal, angled or vertical duct so that rotation axis is always in horizontal position.

Sound power level diagrams

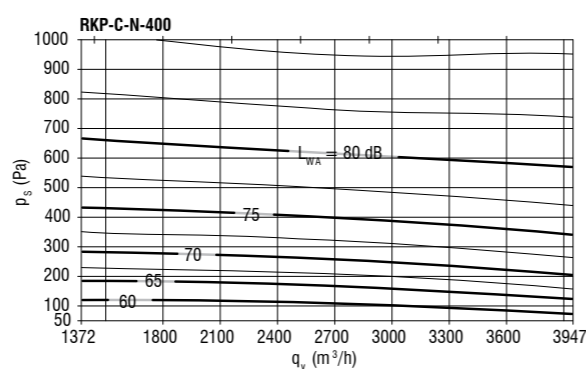
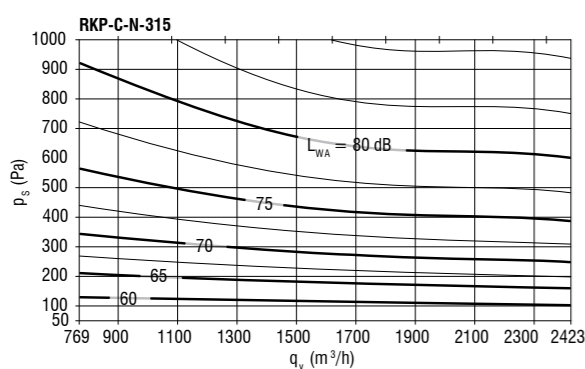
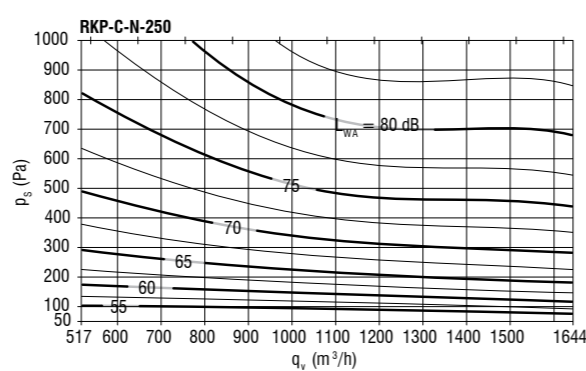
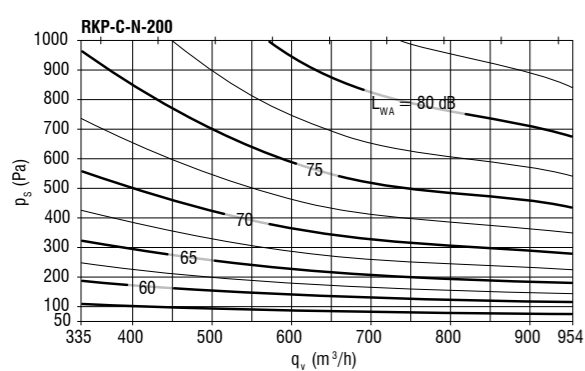
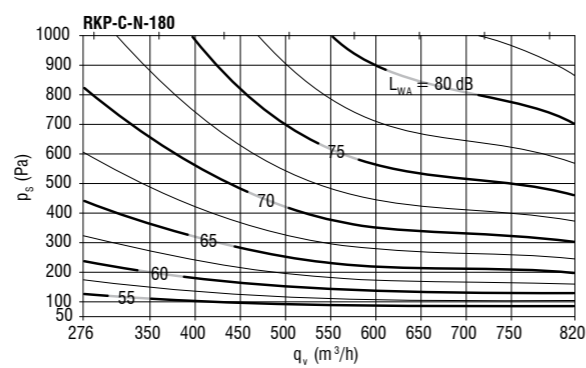
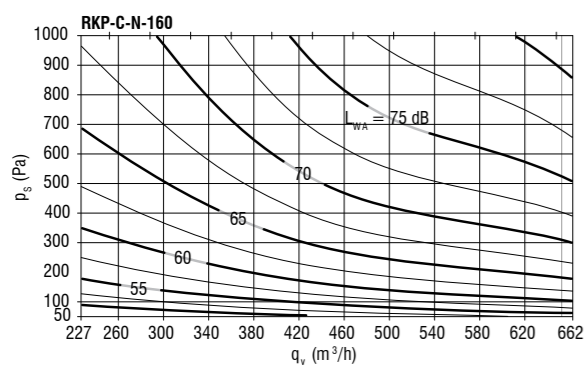
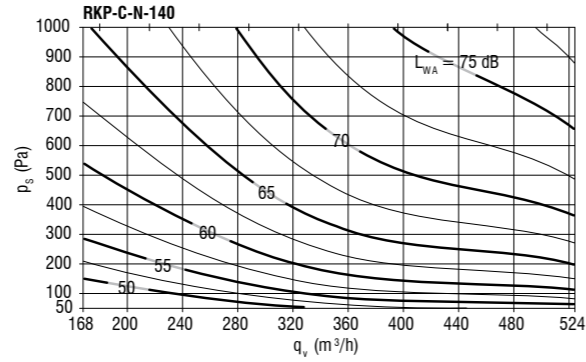
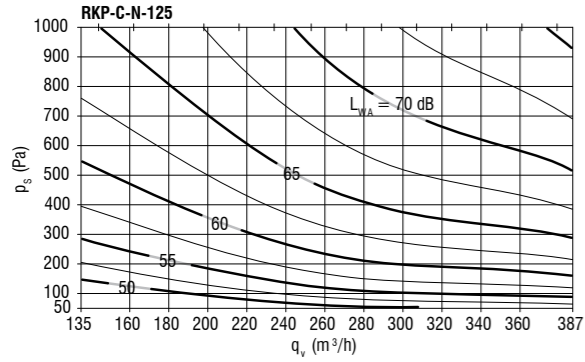
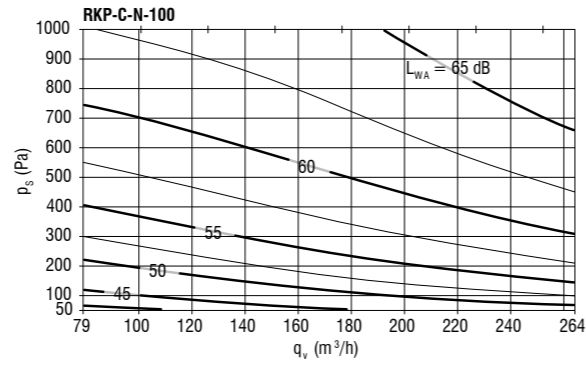
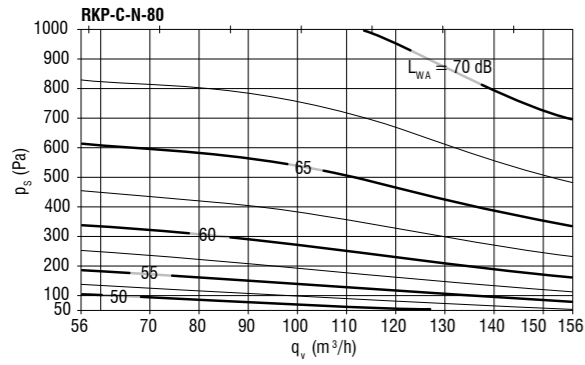

Ordering key:

Constant volume damper **RKP-C-N - ØDn - R - V - Z**  
 Dimensions  
 R - manual drive  
 Air volume flow V [m³/h]  
 Insulation



**RKP-P-N**

- For maintaining constant air volume in ventilation systems, without additional power supply
- Made of galvanized steel sheet, damper blade made of anodized aluminium sheet
- Recommended airflow velocity from 3 to 8 m/s, at pressure difference  $\Delta p > 50$  Pa
- Adjusting required constant amount is done by turning of working screw on the right side of the cover

Working temperature : -20...80°C  
 Relative humidity: 5...80% rh  
 Constant flow:  $\pm 10\%$  set value  
 Casing airtightness: Class C

Dimensions RKP-P-N

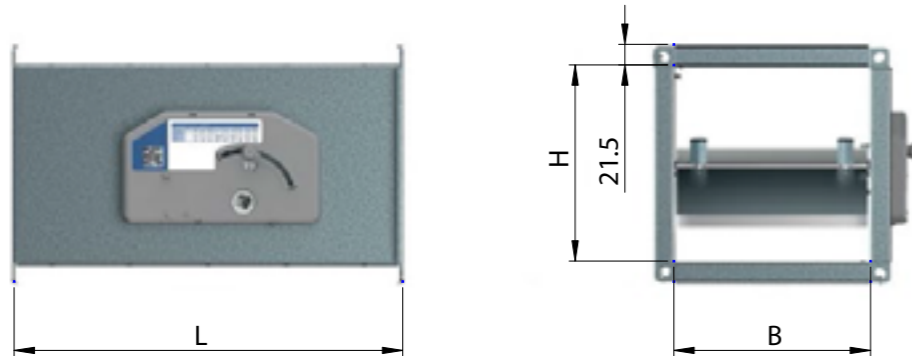

Dimensions RKP-P-Z-N

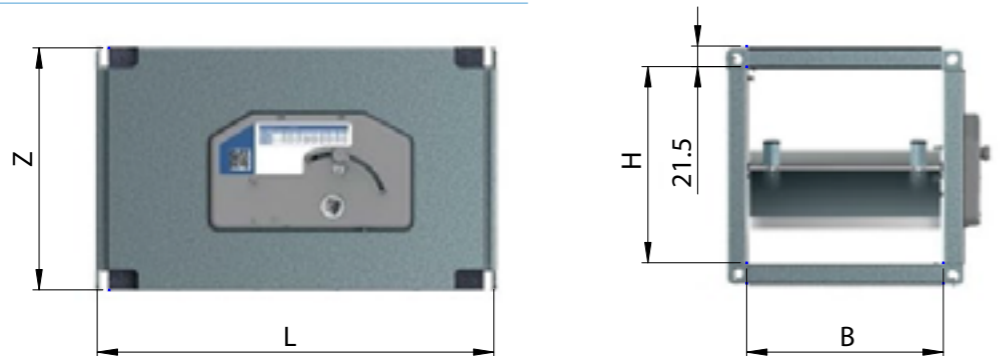

Dimensions

Size B x H (mm)	200 x 100	200 x 200	300 x 100	300 x 150	300 x 200	400 x 200	400 x 250	400 x 300	400 x 400	500 x 200	500 x 250	500 x 300	500 x 400	500 x 500	600 x 200	600 x 250	600 x 300	600 x 400	600 x 500	600 x 600
L (mm)	400	400	400	400	400	400	400	400	400	400	400	400	400	400	400	400	400	400	400	400
Pressure drop (Pa)	732,8	956,2	694,3	794,5	758,5	825,3	833	766,5	833	933,1	797	863,8	876,6	871,2	542,9	663,5	835,6	640,4	650,7	712,3
V <sub>max</sub> (m³/h)	524	1166	787	1312	1749	2332	2916	3499	4665	2916	3645	4374	5832	7290	3499	4374	5248	6998	8748	10497
mass RKP-P (kg)	-	5,3	5,4	5,9	6,4	7,5	8,0	8,7	12,7	8,7	9,2	9,8	14,4	15,4	9,7	10,4	11	16,2	17,4	22,5
mass RKP-P-N (kg)	5,8	7,3	7,4	8,1	8,8	10,5	11,2	12	16,4	12	12,8	13,6	18,6	19,9	13,6	14,4	15,3	20,8	21,9	27

Fast selection diagram

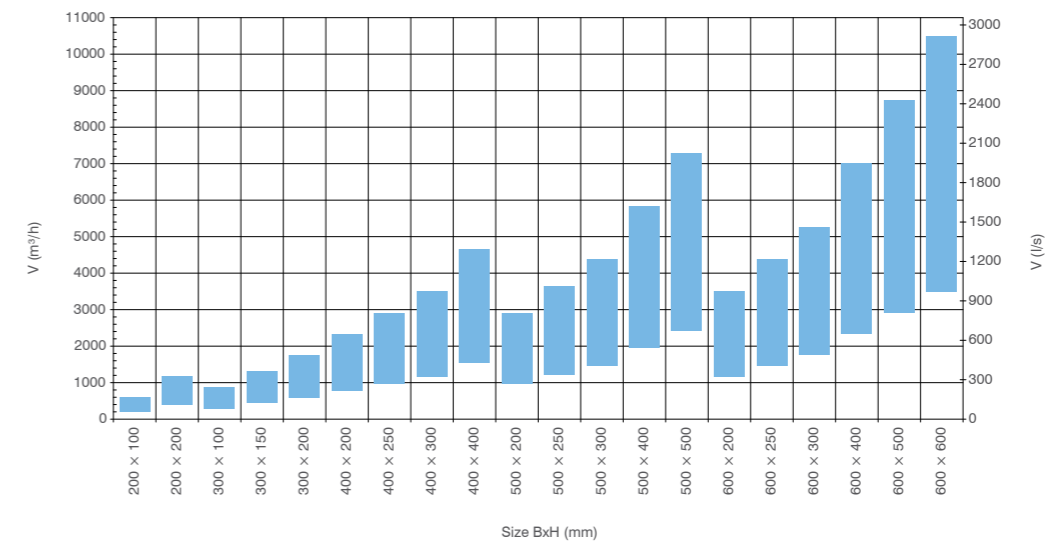

Installation

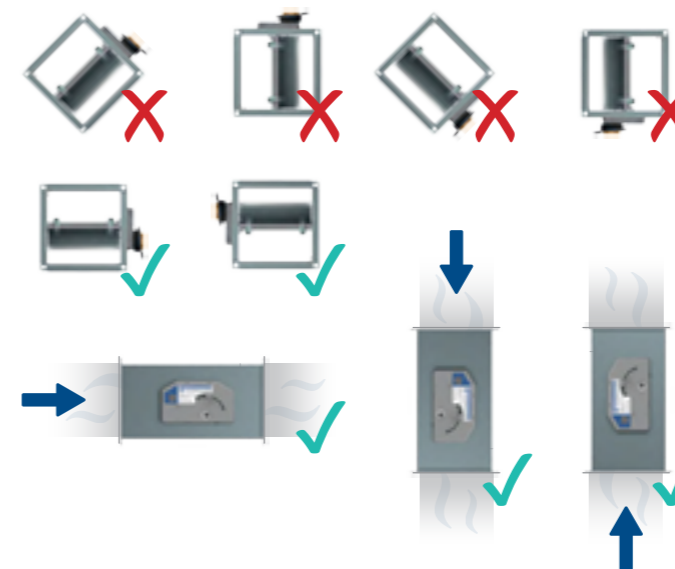
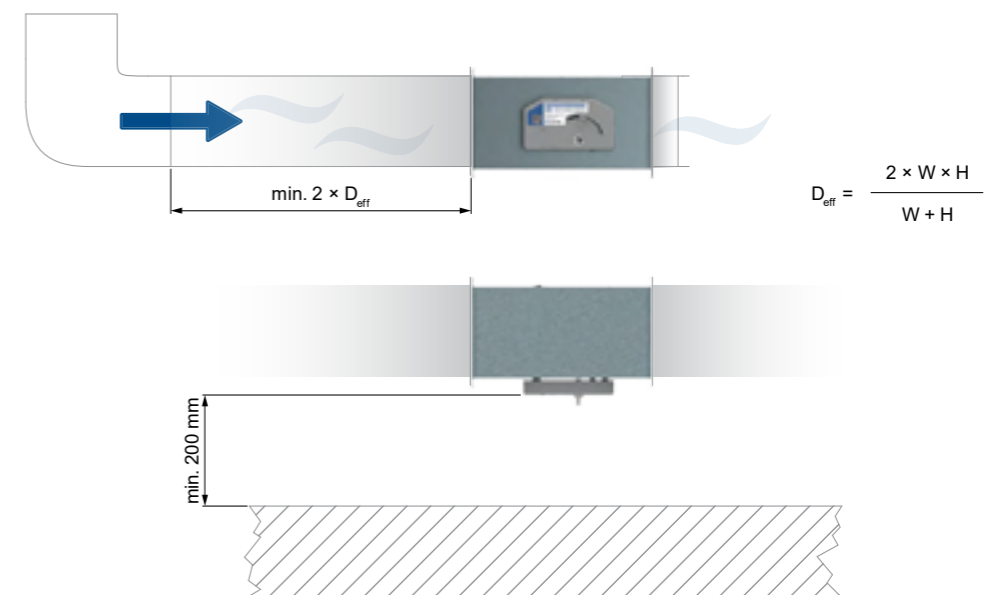

- Required length of straight section before regulator is  $L > 3d$ . If  $L < 3d$ , a 10% error in regulation occurs so that kind of installation is not advisable
- Pay attention to airflow direction marking on the regulator. If not correctly installed, regulator will not work
- Maintenance is not required

Installation in horizontal, angled or vertical duct so that rotation axis is always in horizontal position.

Sound power level diagrams

RPK-P-Z-N 200x100

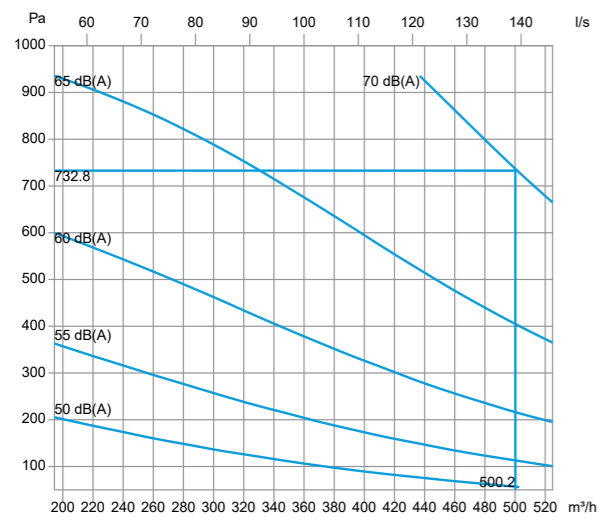

RPK-P-Z-N 200x200

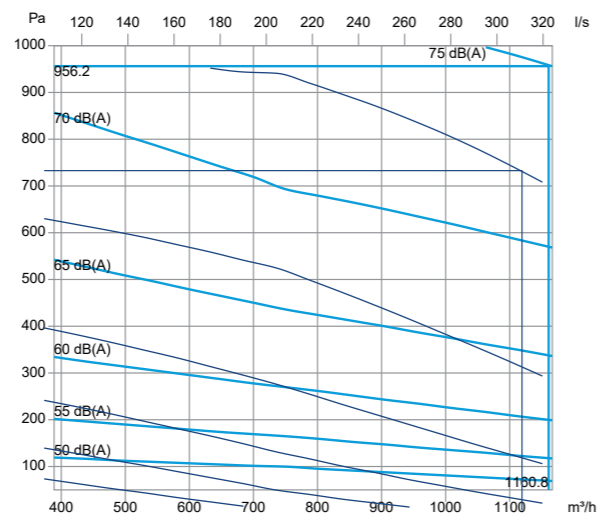

RPK-P-Z-N 500x400

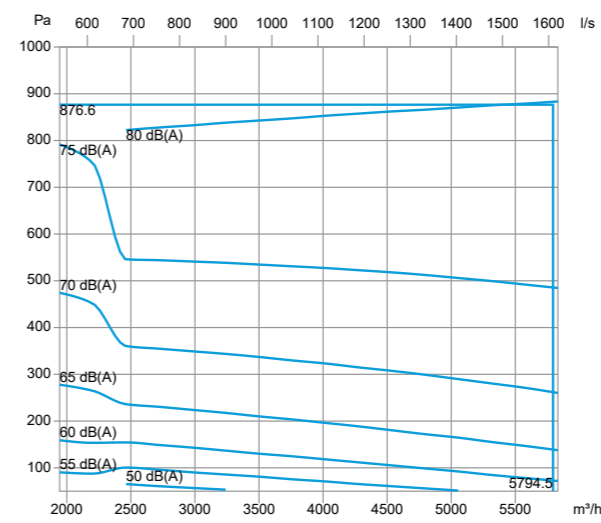

RPK-P-Z-N 500x500

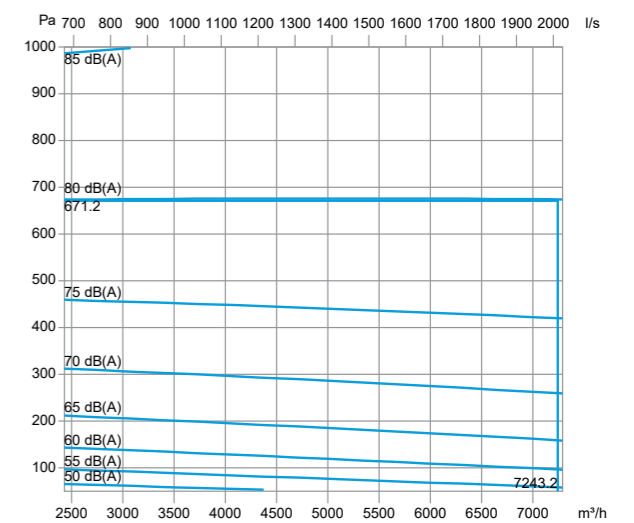

RPK-P-Z-N 300x100

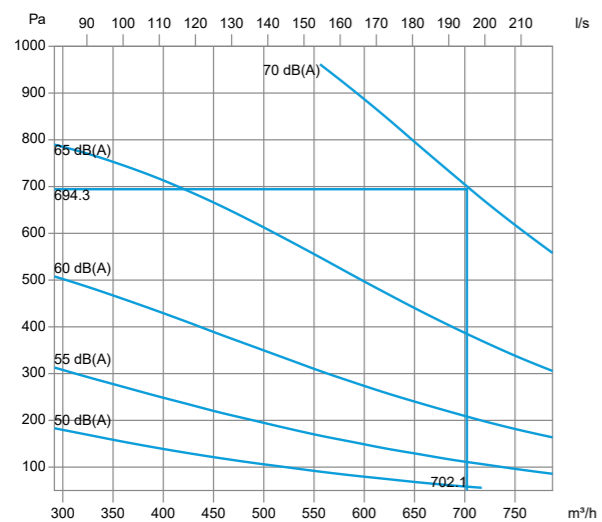

RPK-P-Z-N 300x150

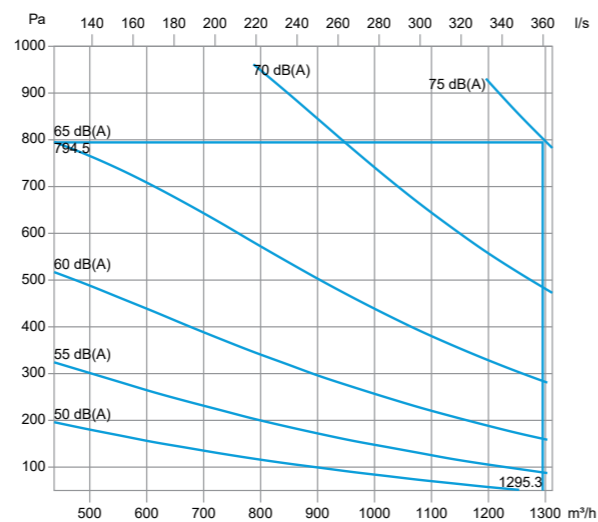

RPK-P-Z-N 600x200

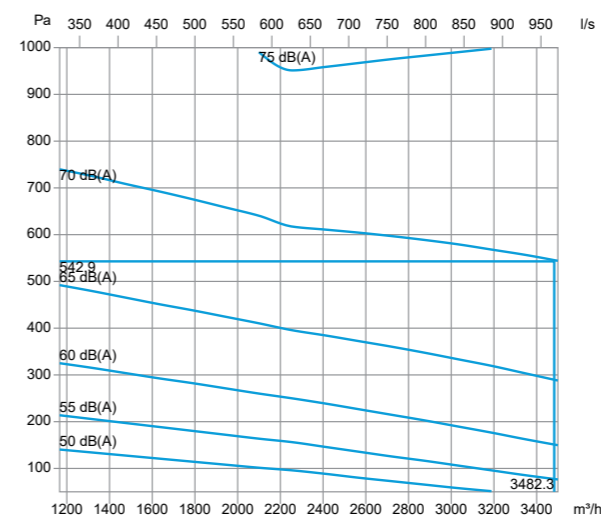

RPK-P-Z-N 600x250

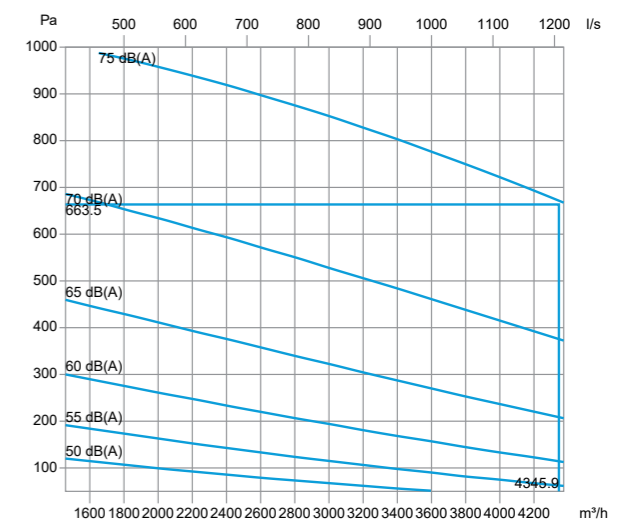

RPK-P-Z-N 300x200

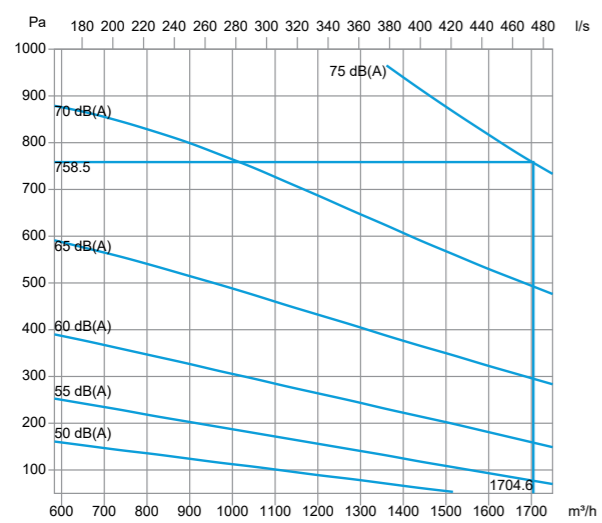

RPK-P-Z-N 400x200

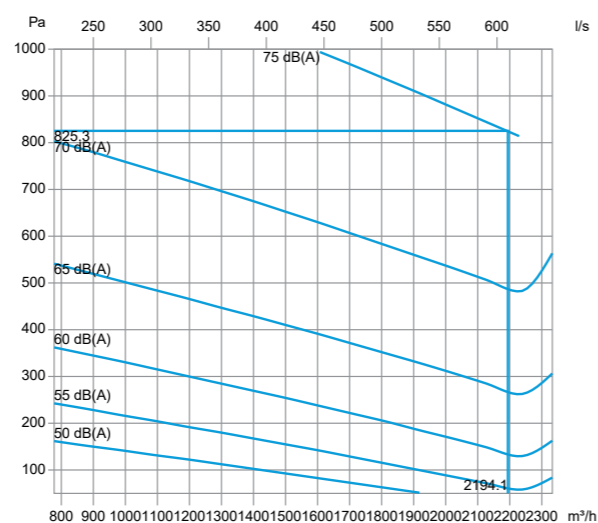

RPK-P-Z-N 600x300

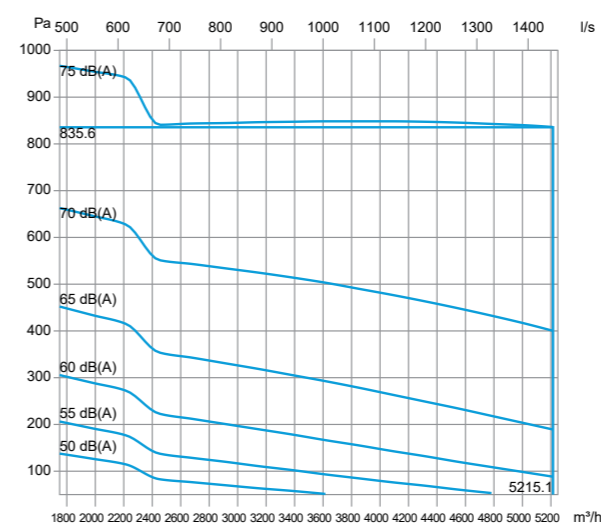

RPK-P-Z-N 600x400

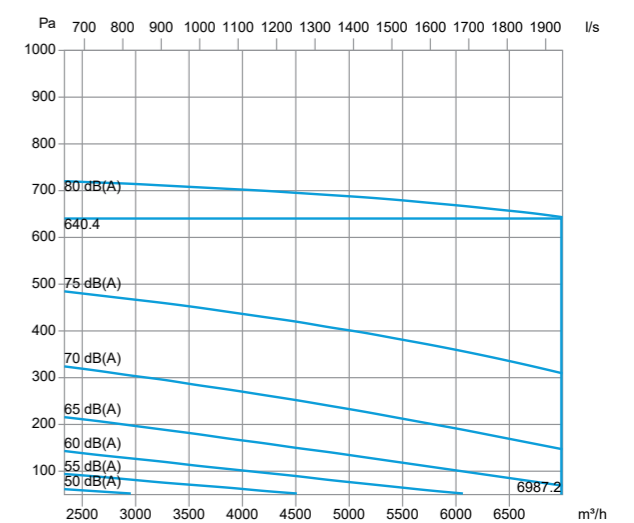



RPK-P-Z-N 400x250-M0

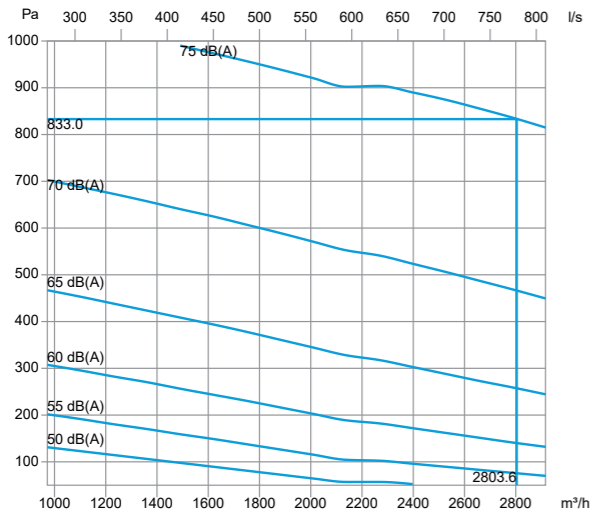

RPK-P-Z-N 400x300

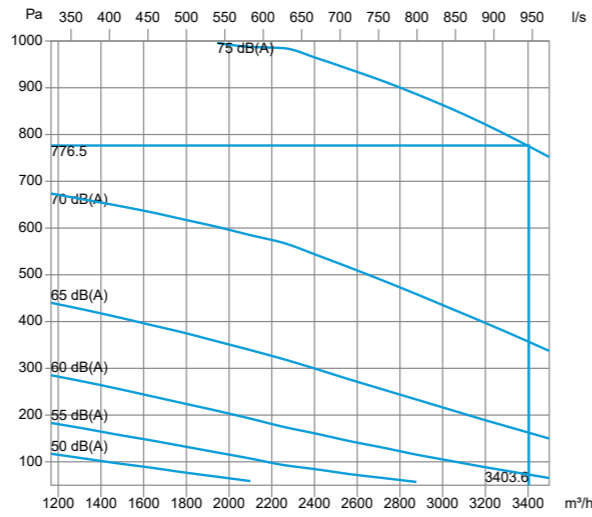

RPK-P-Z-N 600x500

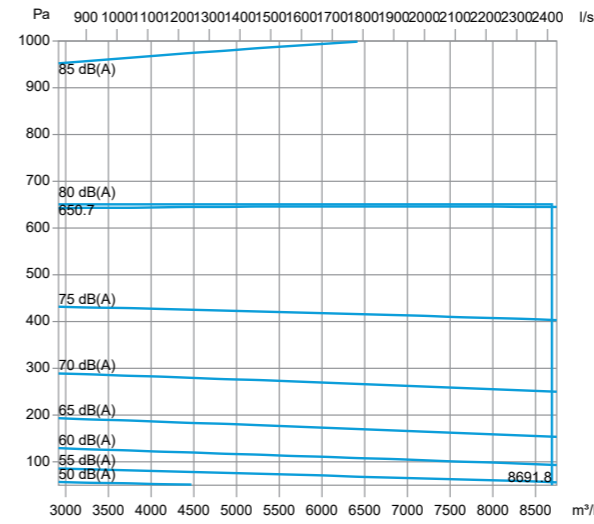

RPK-P-Z-N 600x600

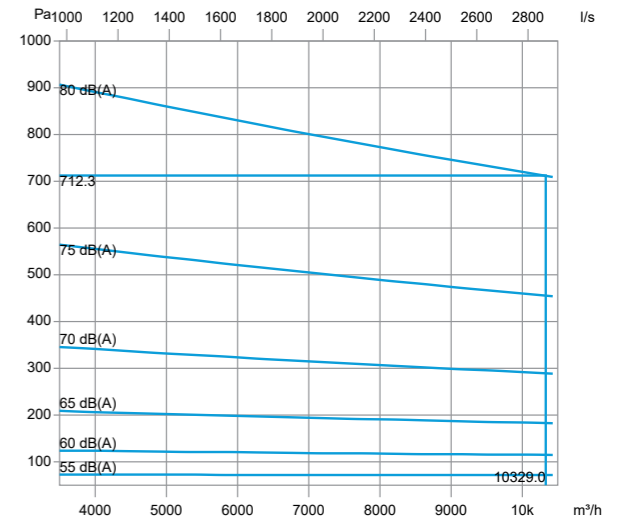

RPK-P-Z-N 400x400

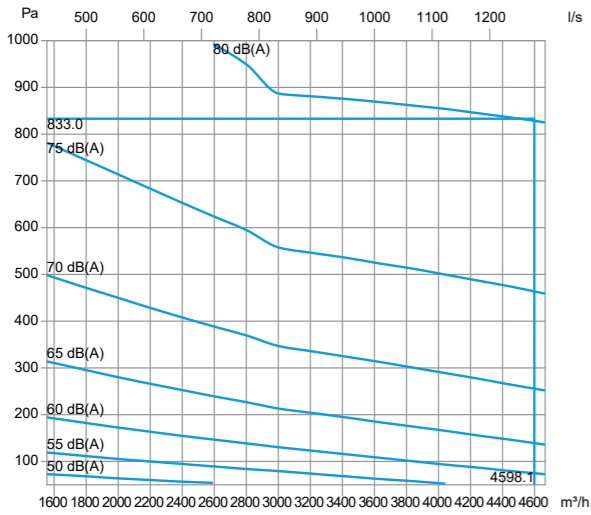

RPK-P-Z-N 500x200

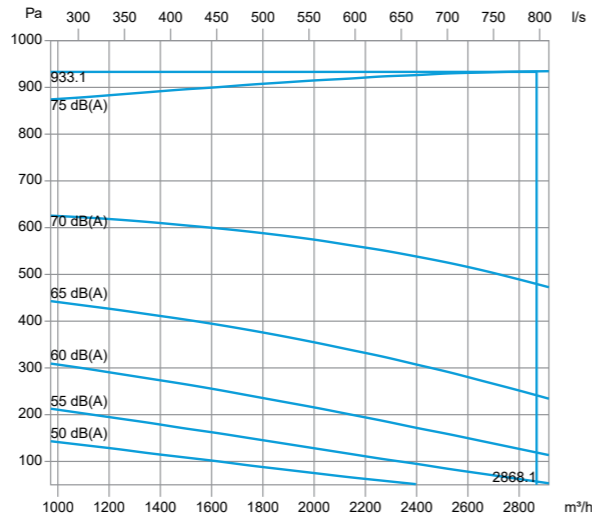

RPK-P-N 200x200

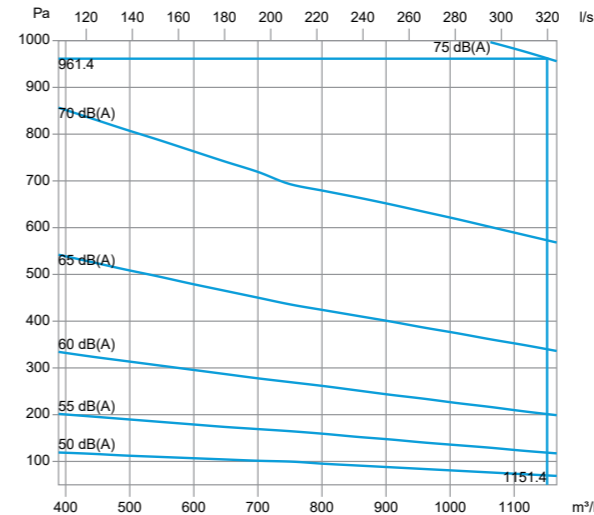

RPK-P-N 300x100

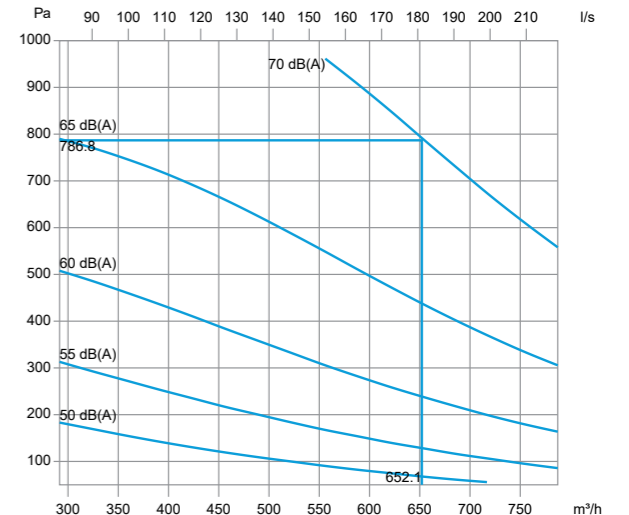

RPK-P-Z-N 500x250

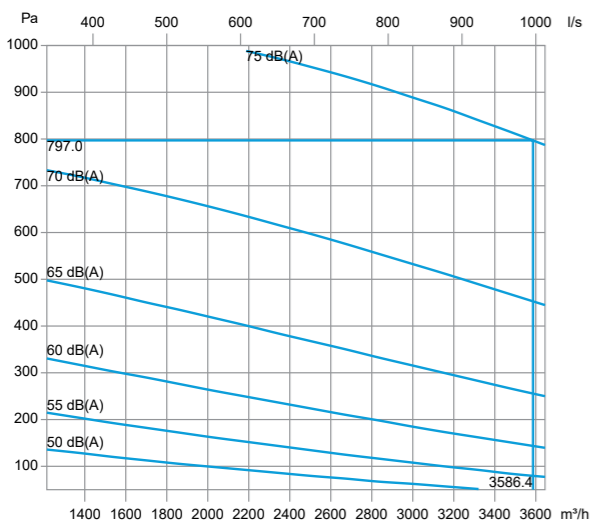

RPK-P-Z-N 500x300

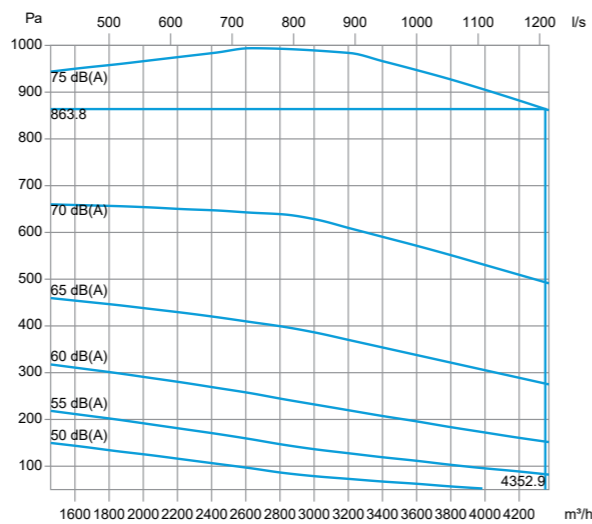

RPK-P-N 300x150

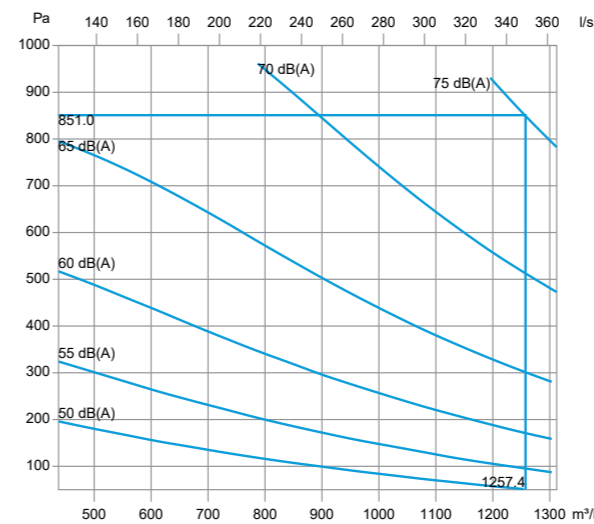

RPK-P-N 300x200

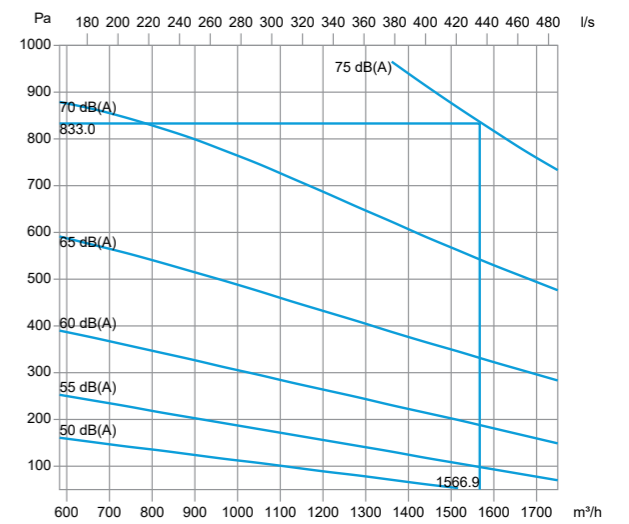

RPK-P-N 400x200

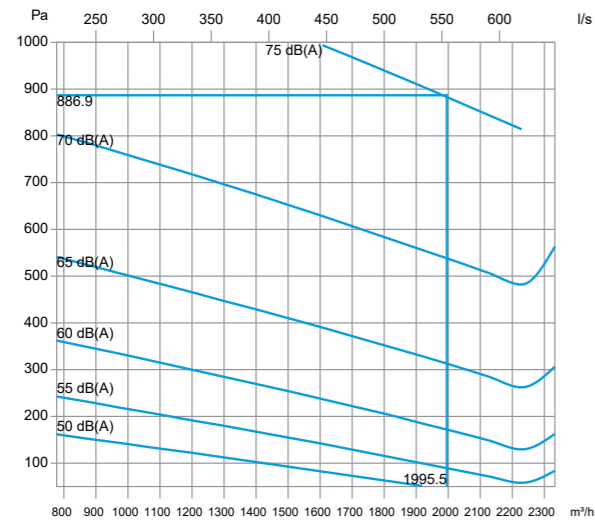

RPK-P-N 400x250

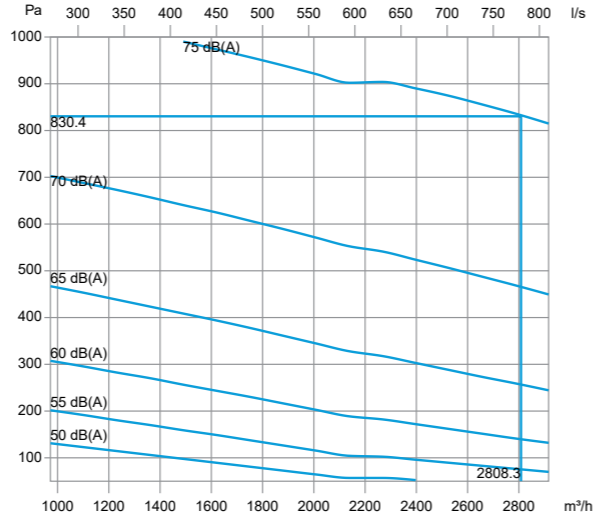

RPK-P-N 500x300

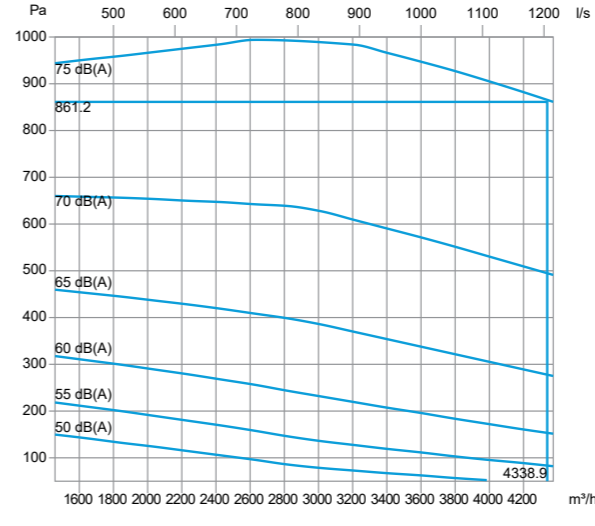

RPK-P-N 500x400

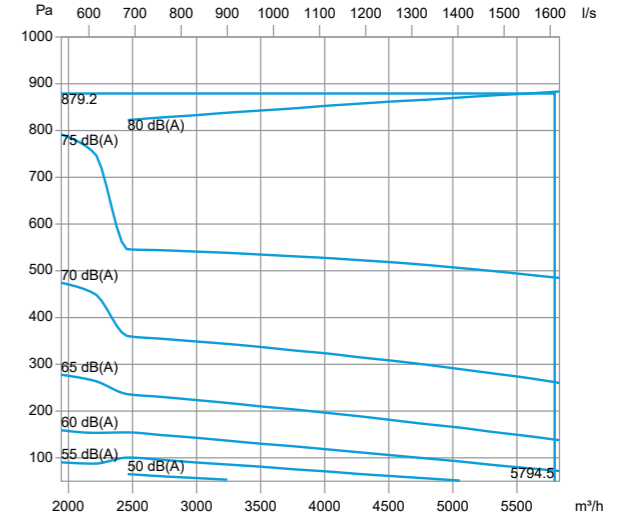

RPK-P-N 400x300

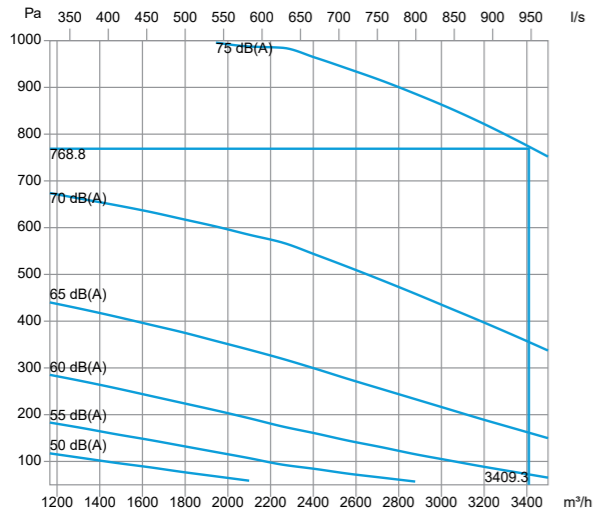

RPK-P-N 400x400

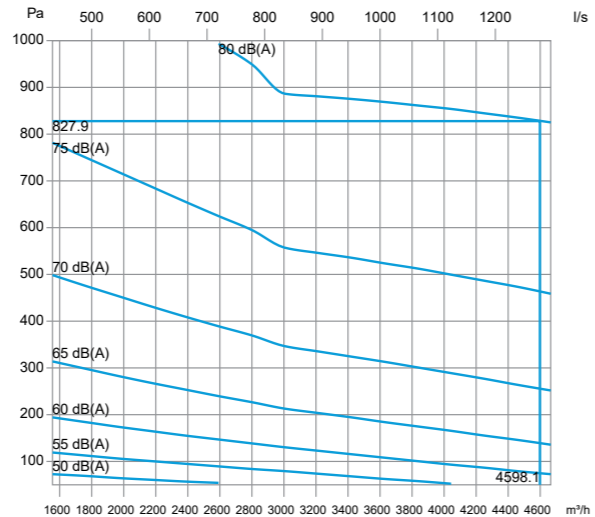

RPK-P-N 500x500

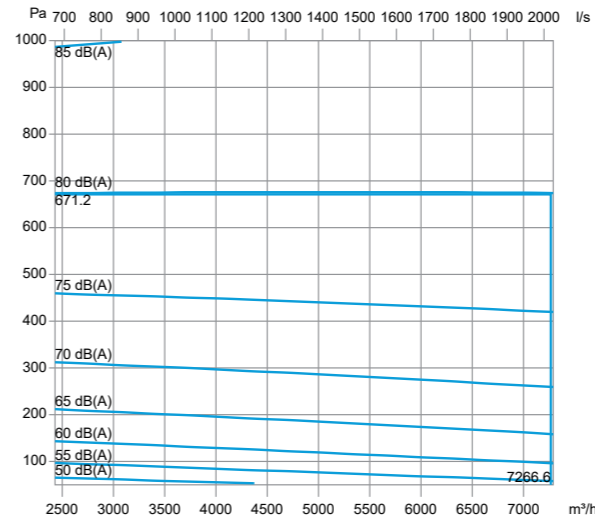

RPK-P-N 600x200

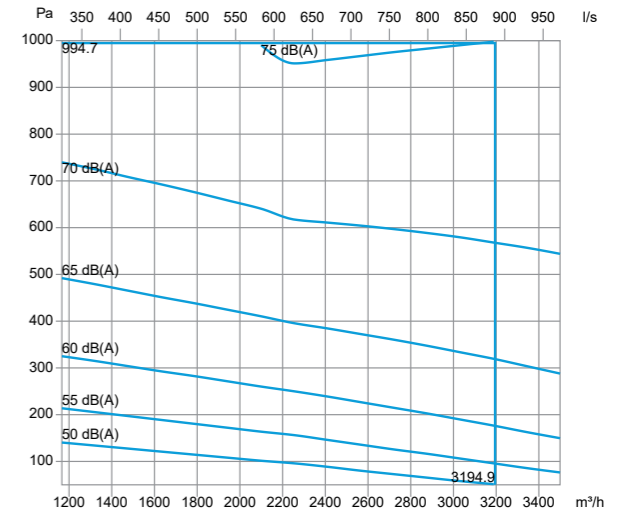

RPK-P-N 500x200

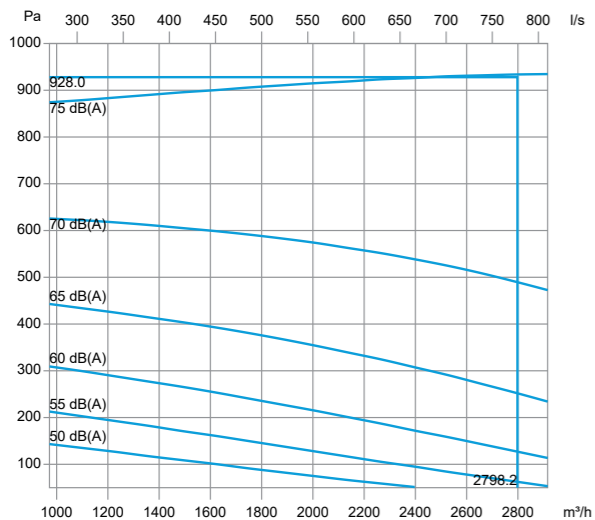

RPK-P-N 500x250

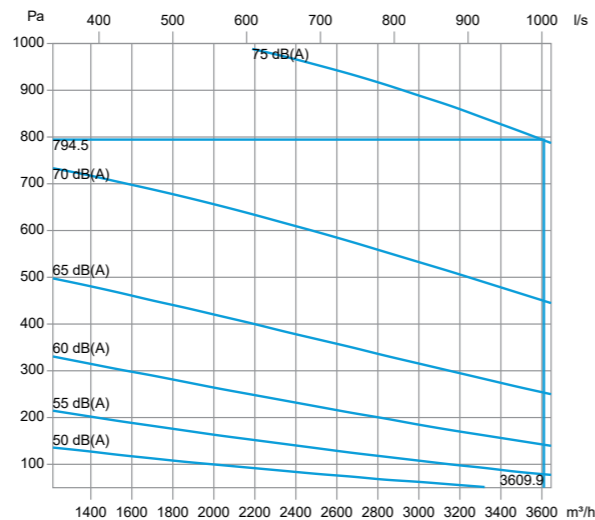

RPK-P-N 600x250

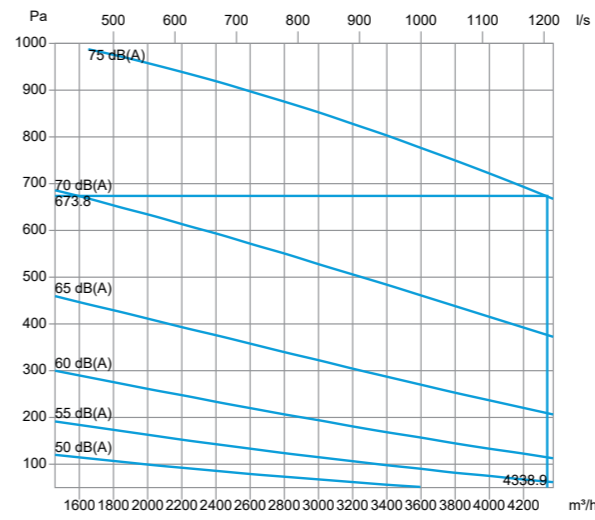

RPK-P-N 600x300

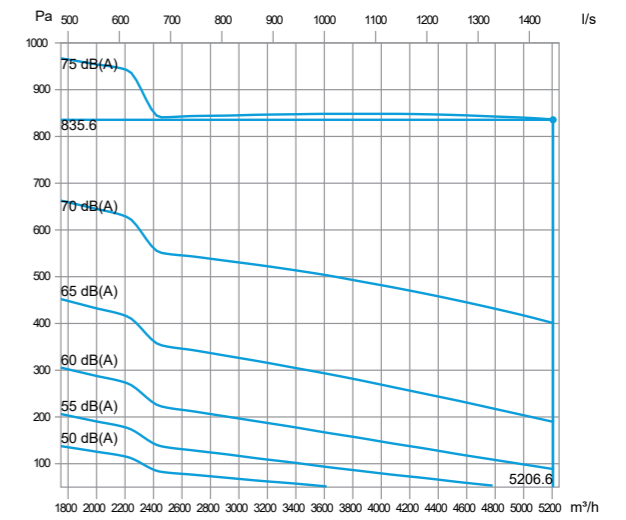

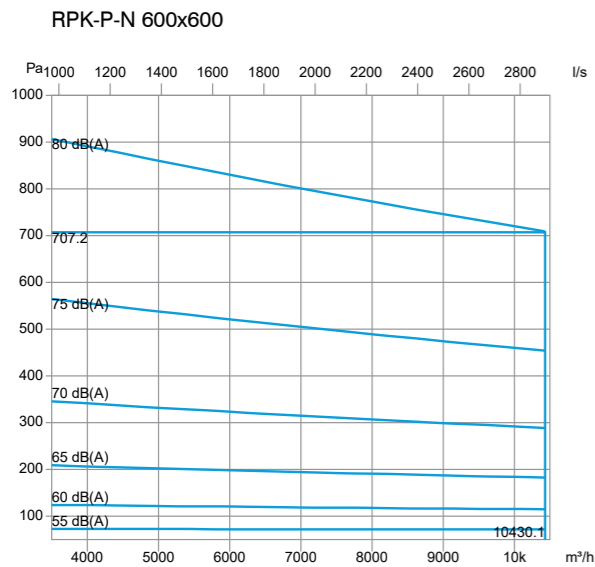
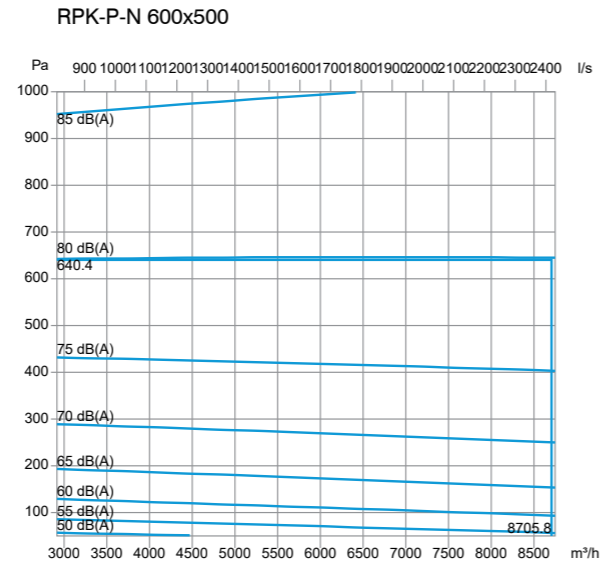
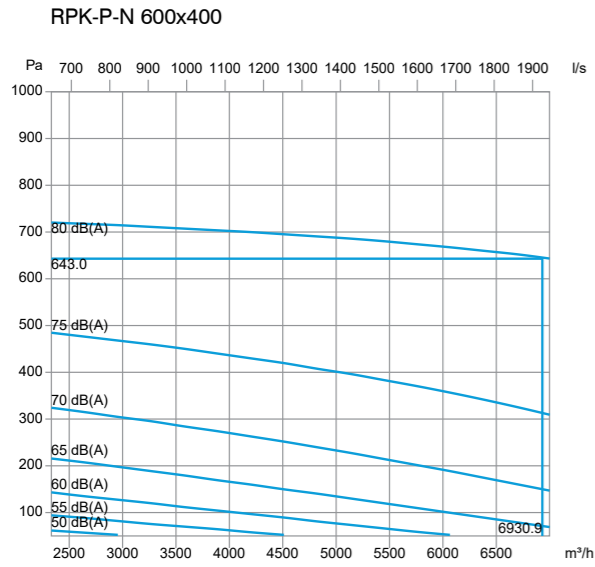

**KVR-R**

- For maintaining constant air volume in ventilation systems, without additional power supply
- Made of fire retardant plastics
- Covers an air flow range between 15 up to 700 m³/h within a pressure range from 50 up to 200 Pa
- Air flow can easily be adjusted within the airflow range of each damper
- Maximum working temperature 60°C

**Material**

- Fire retardant plastics classified M1
- Body, valve and piston made out of fire retardant plastics M1
- Stainless steel calibrated spring
- Rubber air-tight sealing

**Installation**

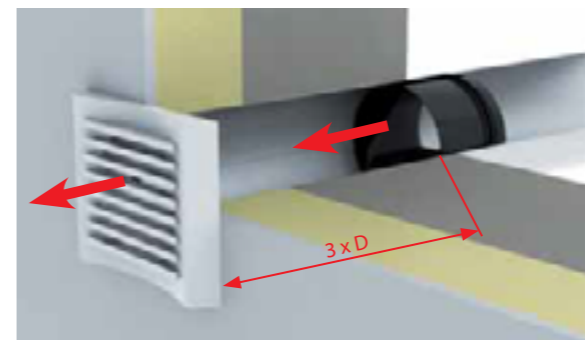
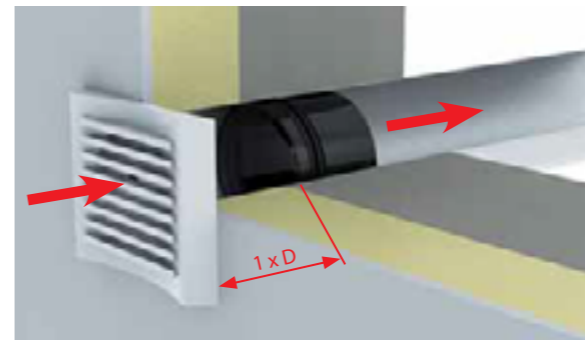

- To be inserted inside round ducts
- For horizontal or vertical mounting
- When horizontally mounted the marking "BAS" must be horizontal
- To be placed according to the marked airflow direction
- To be placed in air supply at a minimum distance of 3x the duct diameter from air supply grilles and at the same distance close to areas with high turbulence like duct connections, bends,...
- To be placed in air exhaust at a minimum distance of 1x the duct diameter from air exhaust grilles and at the same distance close to areas with high turbulence like duct connections, bends,...
- The flow regulator must be accessible to allow maintenance.

**Ordering key:**

Constant volume damper **RPK-P-N - B x H - R - V - Z**  
 Dimensions  
 R - manual drive  
 Air volume flow V [m³/h]  
 Insulation

**Dimensions**

Ø	D1 [mm]	D2[mm]	L[mm]
80	76	73	55
100	96	93	70
125	120	117	89
150	146	148	91
160	146	148	91
200	190	195	91
250	245	236	127



Construction

1. Cuff with seal
2. Spacer (according air volume)
3. Corps
4. Regulator element
5. Flow control module
6. Blocking screw adjustment module

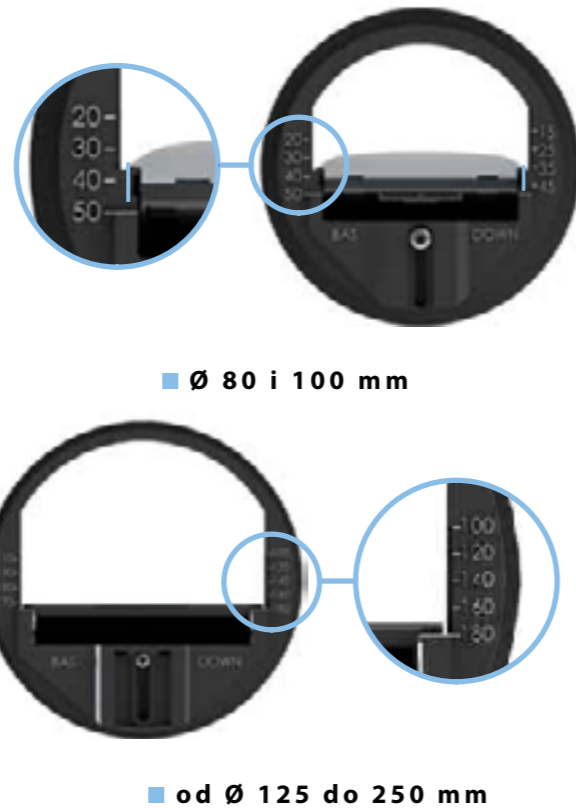

Pressure drop and sound power levels

Qv	Lw			
	50 Pa	100 Pa	150 Pa	200 Pa
15	25	29	32	35
25	26	30	33	36
30	26	31	35	38
45	27	33	36	39
50	29	35	37	41
60	32	37	39	42
75	32	37	40	42
90	32	38	41	44
100	33	39	42	45
120	30	34	39	42
150	33	37	41	45
180	34	40	44	47
210	34	40	42	44
240	35	41	44	47
270	37	43	45	49
300	33	37	42	45
350	35	40	44	47
400	37	42	45	50
450	38	44	46	51
500	39	46	48	53

SELECTION DIAGRAMS

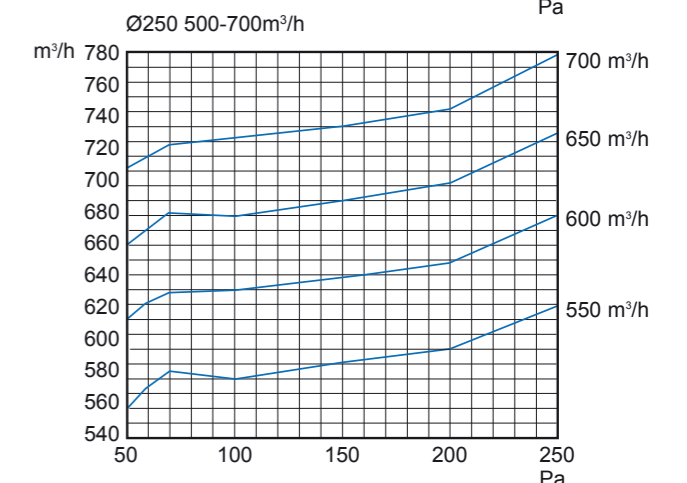
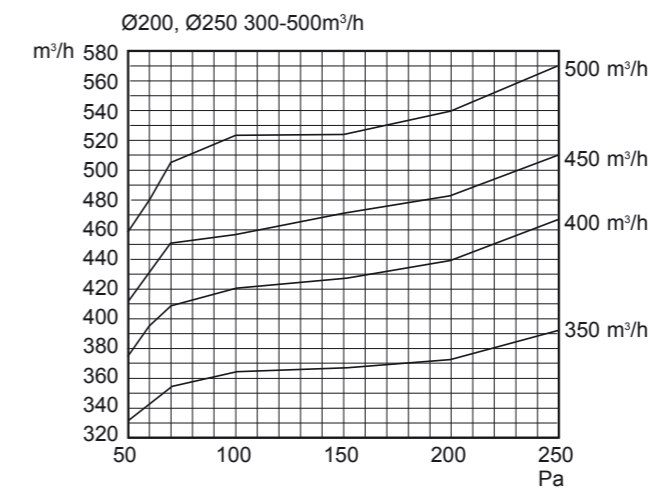
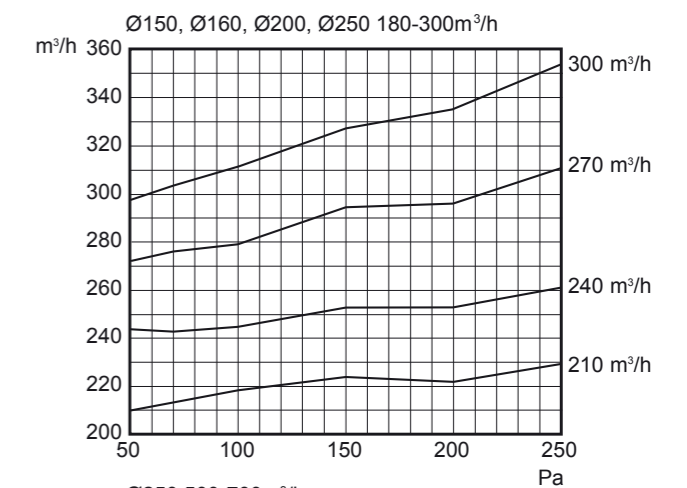
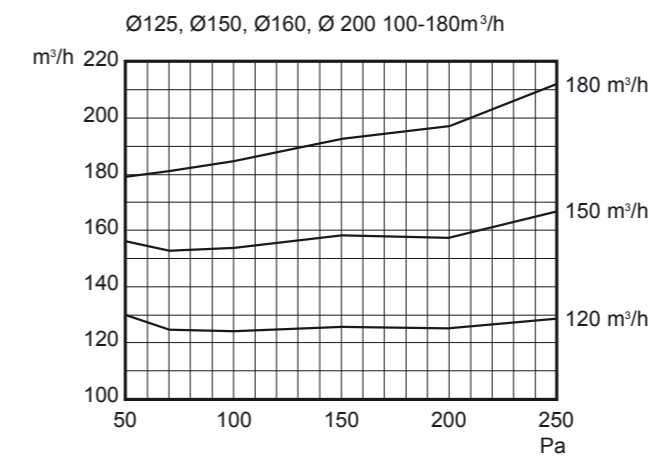
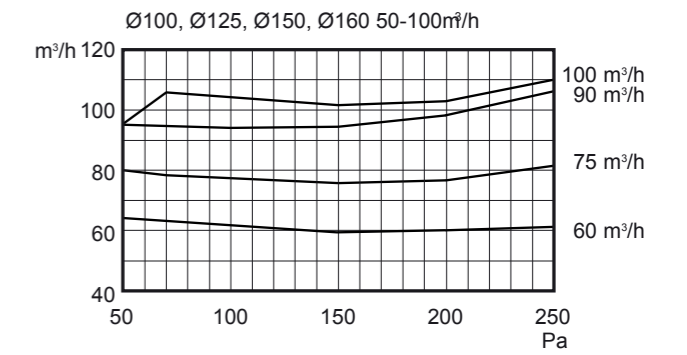
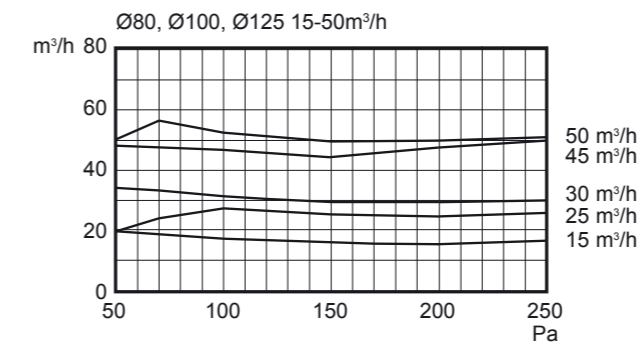

ORDERING KEY

Constant flow regulator **KVR - Ø**  
Dimension